

CONTENTS

1. DESCRIPTION AND APPLICATION OF THE DEVICE	3
1.1 TECHNICAL DATA.....	3
2. SAFE HANDLING GUIDELINES	4
3. SURFACE-MOUNTED MAGNETIC TRACK	5
3.1 SCHEMATIC FOR SURFACE-MOUNTED MAGNETIC TRACK.....	5
3.2 ELEMENTS OF A SURFACE-MOUNTED MAGNETIC TRACK SYSTEM.....	6
3.3 SYSTEM CONFIGURATION.....	7
3.4 INSTALLATION PROCEDURE FOR SURFACE-MOUNTING SUSPENDED MAGNETIC TRACK.....	10
4. CONNECTING POWER TO THE MAGNETIC TRACK	11
4.1 CONNECTING POWER TO THE MAGNETIC TRACK WITH A POWER SUPPLY.....	11
4.2 CONNECTING POWER TO THE MAGNETIC TRACK USING A COMPACT POWER SUPPLY WITH THE ABILITY TO INSTALL DIRECTLY ONTO THE TRACK.....	12
5. RECOMMENDATIONS	13
6. TROUBLESHOOTING	14
7. STORAGE	15
8. TRANSPORTATION	15
9. DISPOSAL	15
10. CERTIFICATION	15
11. WARRANTY	15
12. MANUFACTURER	15
13. IMPORTER	15



1. DESCRIPTION AND APPLICATION OF THE DEVICE

The TRX084 series magnetic track system is the basis for building track lighting and is designed for mounting and supplying power to track lights in the DC electrical power grid with 48V of nominal voltage.

The track system is for internal use only in a non-aggressive environment free of aerosol particles and where a temperature range of 0°C to +50°C is guaranteed. The relative humidity should be equal to less than 80 percent. It is possible to mount the track system to walls and ceilings made out of mildly flammable materials. The other option would be to carry out installation with cable suspensions. The track system is delivered in different lengths: either 1 or 2 metres. It is possible to cut and connect these tracks in various forms in order to assemble configurations depending on bespoke requirements. Since the entire system is built specifically for 48V of nominal voltage, it is essential to select the correct power source to light every bulb in the circuit.

It is crucial to note that the reserve power supply should not be less than 20% of the overall power consumption for optimal performance. This ratio provides support for reliable, continuous use and prevents the luminaires from overheating.

1.1 TECHNICAL DATA

Size	1m	2m
Surface mounted track model	TRX084-111B	TRX084-111W
Recessed mounted track model	TRX084-112B	TRX084-112W
Rated voltage	DC 48V	
Electrical shock protection class	III	
Mounting method	surface-mounted/recessed	
Ingress Protection Code	IP20	
Climatic version	Boreal climate (4)	
Operating temperature	0°C - +50°C	
Material	Aluminum	

TRX084-111B
TRX084-111W
TRX084-112B
TRX084-112W

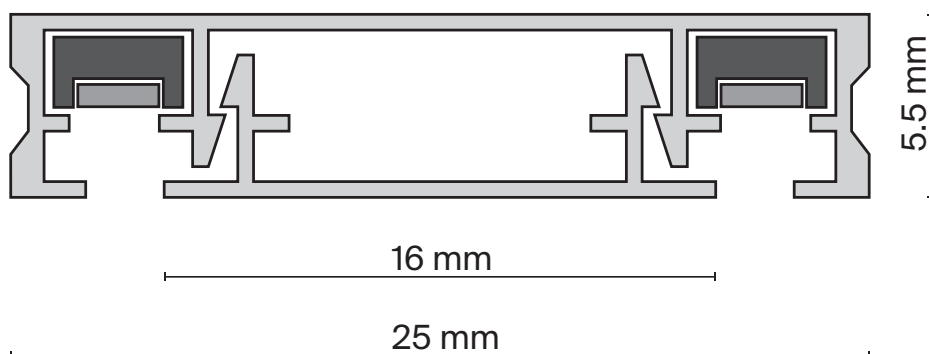

2. SAFE HANDLING GUIDELINES

All installation and mounting services must be rendered by persons with the appropriate permits and qualifications. Please contact a qualified electrician where necessary. All installation and dismantling work should be performed in a powered down state only. Operation of the track without a power source is forbidden. Do not connect the track directly to the 230V 50Hz AC mains to prevent failure of the luminaires.

When building a track system, do not exceed the total current load of the selected power source keeping the power reserve of 20% in mind.

Do not use the product if the housing and/or supply cable insulation is damaged. The product is intended for indoor use only.

Do not use the product in rooms with high humidity and with a high content of dust or aerosol particles in the air.

Use a soft, dry cloth to clean the product with the power switched off. Do not use chemically aggressive cleaning agents.

3. SURFACE-MOUNTED MAGNETIC TRACK

3.1 SCHEMATIC FOR SURFACE-MOUNTED MAGNETIC TRACK

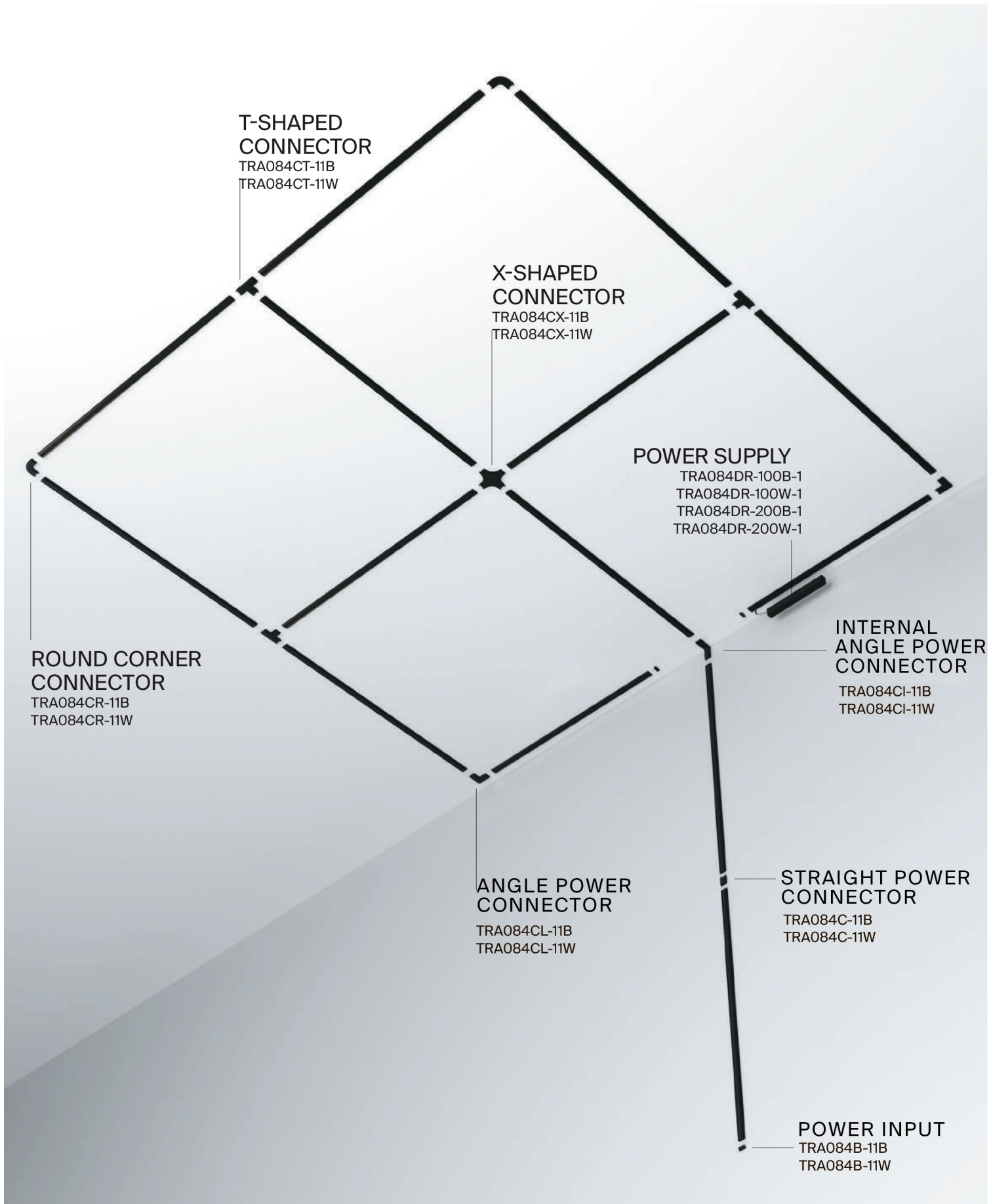

3.2 ELEMENTS OF A SURFACE-MOUNTED MAGNETIC TRACK SYSTEM





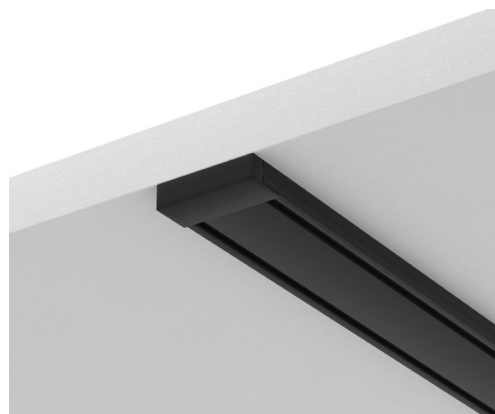
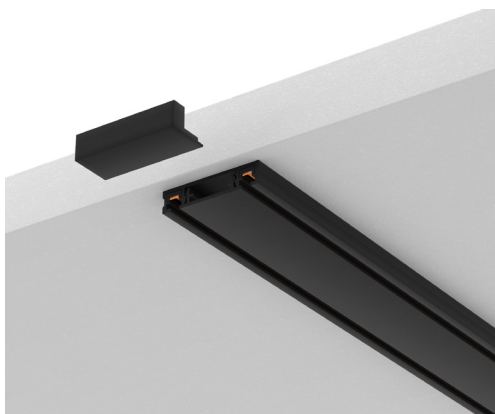
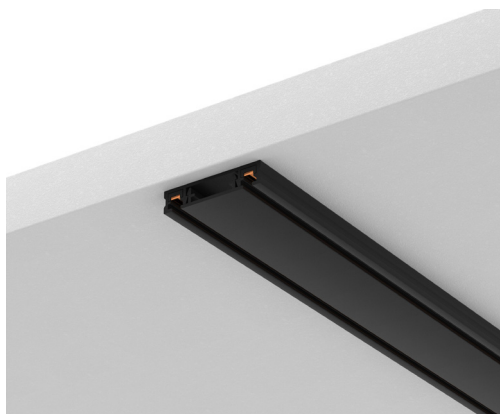

SYSTEM ELEMENT	COLOR	ARTICLE	SIZE
SURFACE-MOUNTED TRACK	■ BLACK	TRX084-111B	H5.5 X W25 X L1000
	□ WHITE	TRX084-111W	H5.5 X W25 X L1000
	■ BLACK	TRX084-112B	H5.5 X W25 X L2000
	□ WHITE	TRX084-112W	H5.5 X W25 X L2000

PLUGS ARE NOT INCLUDED, THEY ARE PURCHASED SEPARATELY.

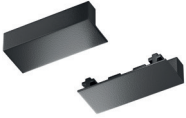
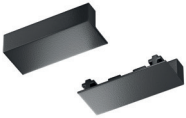



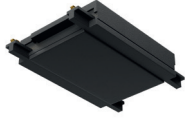







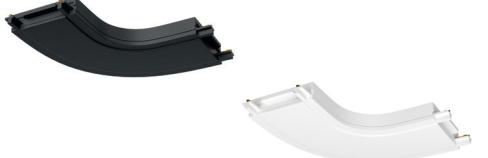

3.3 SYSTEM CONFIGURATION

TRX084-111 / TRX084-112 KITS DIFFER FROM EACH OTHER IN THE NUMBER OF SCREWS FOR MOUNTING A TRACK OF 1 METRES AND 2 METRES.

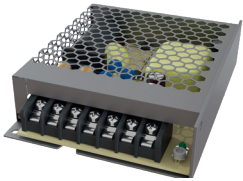
SYSTEM ELEMENT	COLOR	ARTICLE	
MOUNTING KIT WITH PLUGS, 2PCS FOR TRX084	■ BLACK	TRA084B-11B	
	□ WHITE	TRA084B-11W	
MOUNTING KIT WITH PLUGS, 2PCS FOR TRX084	■ BLACK	TRA084EC-112B	
	□ WHITE	TRA084EC-112W	
SURFACE MOUNTED POWER SUPPLY	■ BLACK	TRA084B-11B	
	□ WHITE	TRA084B-11W	
T-CONNECTOR	■ BLACK	TRA084CT-11B	
	□ WHITE	TRA084CT-11W	
X-CONNECTOR	■ BLACK	TRA084CX-11B	
	□ WHITE	TRA084CX-11W	
STRAIGHT CONNECTOR	■ BLACK	TRA084C-11B	
	□ WHITE	TRA084C-11W	
INTERNAL CONNECTOR	■ BLACK	TRA084CI-11B	
	□ WHITE	TRA084CI-11W	

3.3 SYSTEM CONFIGURATION

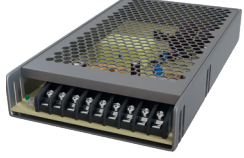
TRX084-111 / TRX084-112 KITS DIFFER FROM EACH OTHER IN THE NUMBER OF SCREWS FOR MOUNTING A TRACK OF 1 METRES AND 2 METRES.

SYSTEM ELEMENT	COLOR	ARTICLE	
ANGLE CONNECTOR	 BLACK	TRA084CL-11B	
	 WHITE	TRA084CL-11W	
SEMICIRCULAR CONNECTOR	 BLACK	TRA084CR-11B	
	 WHITE	TRA084CR-11W	
POWER SUPPLY MEAN WELL 48W, 100V	 GREY	TRX004DR-100S	
POWER SUPPLY MEAN WELL 48W, 150V	 GREY	TRX004DR-150S	
POWER SUPPLY MEAN WELL 48W, 200V	 GREY	TRX004DR-200S	
POWER SUPPLY MEAN WELL 48W, 350V	 GREY	TRX004DR-350S	

3.3 SYSTEM CONFIGURATION

SYSTEM ELEMENT	COLOR	ARTICLE
RECESSED POWER SUPPLY 48W, 100V	■ BLACK	TRA084DR-100B
	□ WHITE	TRA084DR-100W
RECESSED POWER SUPPLY 48W, 200V	■ BLACK	TRA084DR-200B
	□ WHITE	TRA084DR-200W
TRACK ADAPTER	■ BLACK	TRA084FC-11SB
	□ WHITE	TRA084FC-11SW
TRACK ADAPTER	■ BLACK	TRA084FC-11LB
	□ WHITE	TRA084FC-11LW

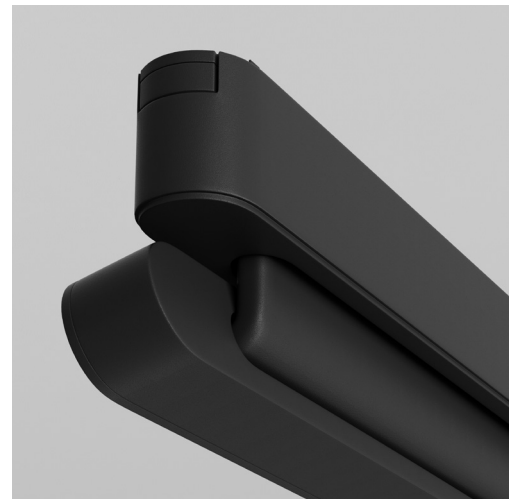

3.4 INSTALLATION PROCEDURE FOR SURFACE-MOUNTING SUSPENDED MAGNETIC TRACK

1. Attach the track on the surface with self-tapping screws.
2. Install the connected power input into the track, through the prepared hole.
3. Install the plugs on the track.

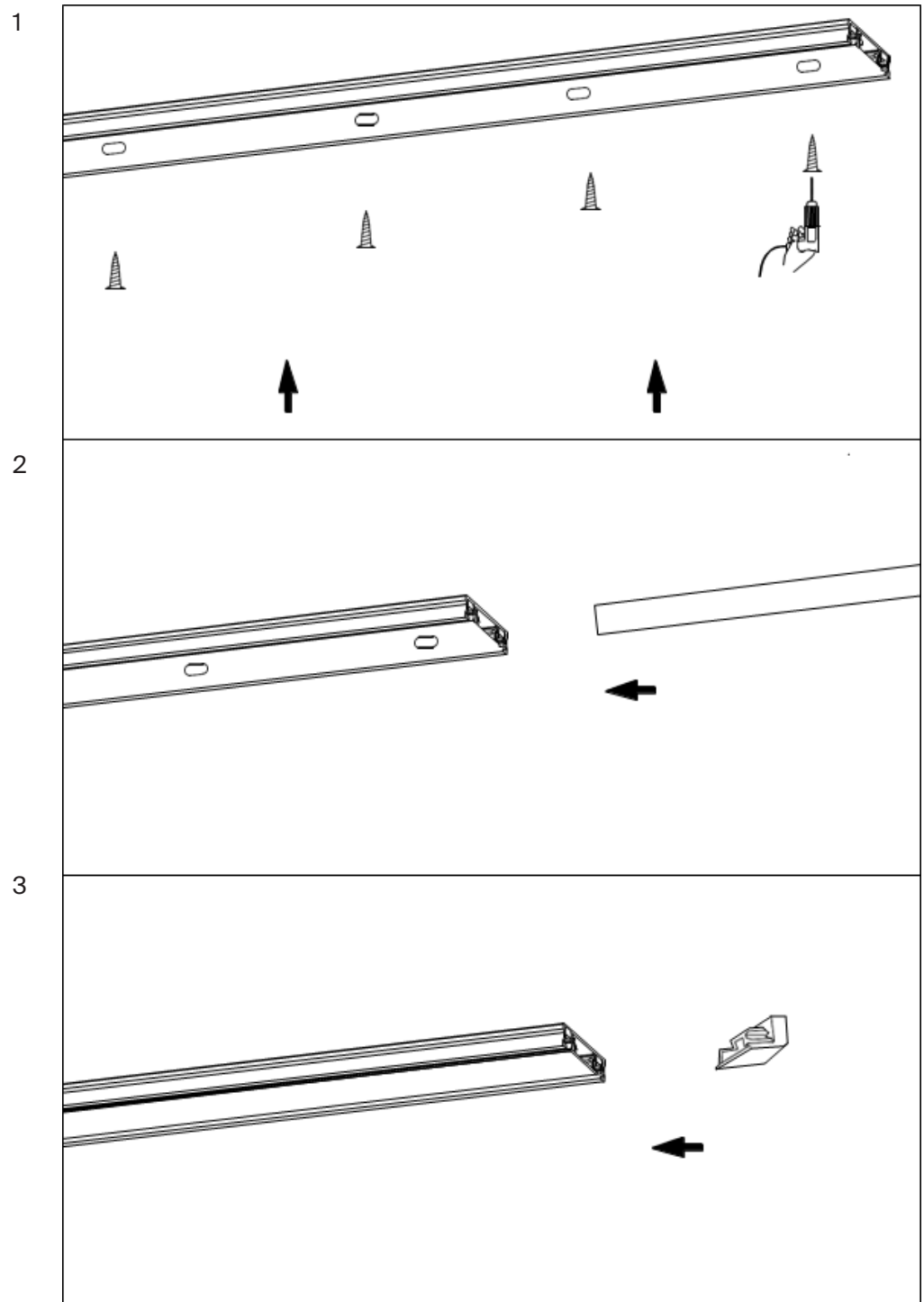

4. CONNECTING POWER TO THE MAGNETIC TRACK

4.1 CONNECTING POWER TO THE MAGNETIC TRACK WITH A POWER SUPPLY

1. Prepare a niche, place a driver in it and bring a 230V 50Hz power cable to it.
2. Connect the power supply to the network 230V 50Hz according to specifications. Power supply should have at least 20% redundancy. If one of the power supplies doesn't have enough power, use the power supply with more output or divide the circuit into multiple smaller ones, using one power supply for each.
3. Connect the power input of the track to the appropriate terminals of the driver (red wire to the V+ terminal, black wire to the V-terminal).
4. Install the connected power inlet to the track. Connection is carried out when the electrical network is switched off.
5. Install the luminaire into the track until it clicks.

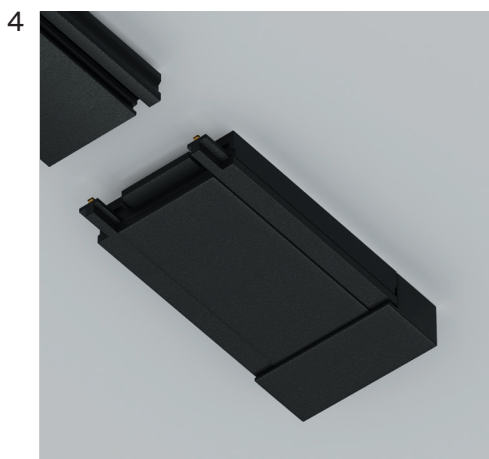
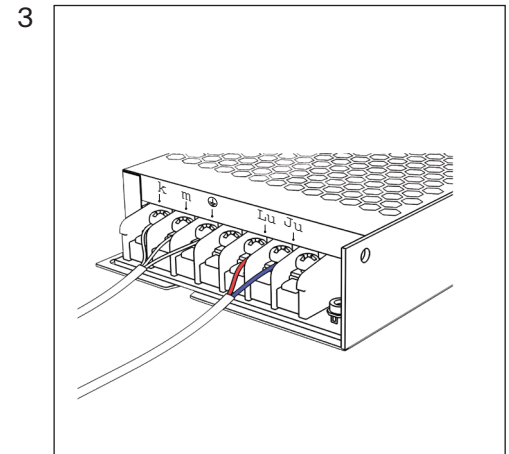
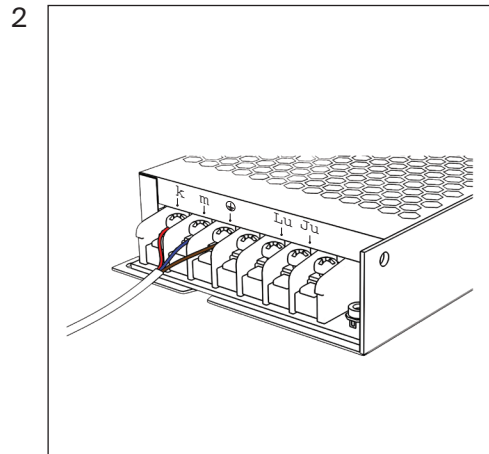
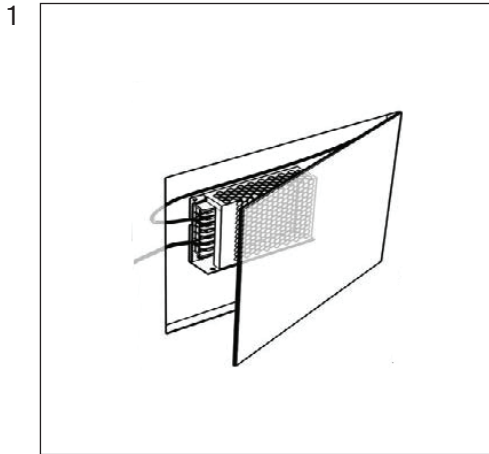

4.2 CONNECTING POWER TO THE MAGNETIC TRACK USING A COMPACT POWER SUPPLY WITH THE ABILITY TO INSTALL DIRECTLY ONTO THE TRACK

When using this power supply, there is no need for power input. These sources are selected in terms of power in the same way as blocks recessed into niches and require 20% of the total load of the connected luminaires.

1. Connect the track power supply to the mains according to the marking on the input cable (G –ground, L–phase, N –neutral). The connection is carried out when the electrical network is switched off.
2. Place the luminaire connection in the track housing.
3. Install the luminaire in the track until it clicks.



5. RECOMMENDATIONS

1. When planning the placement of system elements, be sure to include an inspection hatch in the project to service the driver.
2. Do not deform the track during transport and installation.
3. When cutting track, use professional equipment, or use the services of an organisation providing such services.
4. Through 1 power input, you can connect luminaires with a maximum total power of 400W and a track no longer than 20 metres. If the specified power or length is exceeded, it is necessary to connect subsequent sections through a new power input.
5. The power input can be installed in any section of the track, guided by rule, that one power input feeds no more than 20 metres of the track.
6. Be extremely precise when laying out and installing the wall brackets. If you move them out of the path of the track, you may have difficulty installing it.

6. TROUBLESHOOTING

Fault description	Cause	Troubleshooting
The luminaire does not work	Loose connection of current-carrying parts	Install the lamp on the track until the adapter is in full contact with the current-carrying cores <hr/> Check the input cable connection terminals, the connection of the power input terminals to the track, and other connections.
	luminaire failure	Contact the seller for a replacement under warranty
The lighting fixture flashes or glows dimly in switched-off state	To control the lighting circuit, a switch with key backlighting is installed, or a motion (light) detector is used	Replace the switch with a model without key backlighting, or which has an additional resistor in its design. Use motion (light) detector only with relay output
Unstable glow, flickering, extraneous noise	Brightness control (dimmer switch) is installed in the power supply circuit	Remove the dimmer from the circuit, replace it with a switch
	Faulty power supply	Contact the seller for a replacement under warranty

- 7. STORAGE** The goods are stored in packaging indoors in the absence of an aggressive environment. Storage temperature in the range from -20°C to +70°C and relative air humidity not more than 95%. Do not expose directly to moisture.
- 8. TRANSPORTATION** The packaged product is suitable for transportation by sea, rail, road and air.
- 9. DISPOSAL** The product in its design does not contain toxic and chemically hazardous compounds, therefore it is subject to the rules for the disposal of municipal solid waste.
- 10. CERTIFICATION** Safety Standards, Regulations, Requirements EC.
- 11. WARRANTY** The warranty for the product is 24 months from the date of sale, which is established per the sale documentation.
- Warranty service is provided if the malfunction occurred due to the defect in workmanship, and also subject to all the rules of operation, transportation and storage given in this manual.
- The warranty is not valid in the following cases: if the product has been used for purposes that do not correspond to its intended use; the defect arose after the transfer of the goods to the consumer and is caused by incorrect or careless handling, non-compliance with the requirements given in this manual. And also in cases of force majeure, including: fire, flood, high-voltage discharges and other natural disasters, accidents and deliberate actions of third parties that caused the product to malfunction.
- 12. MANUFACTURER** Maytoni GmbH, Feldstiege 98, Münster, Germany, 48161
- 13. IMPORTER** Maytoni GmbH, Feldstiege 98, Münster, Germany, 48161
www.maytoni.de
Developed in Germany.
Made in China.
Shelf life is not limited.

